



Network Speaker

Operating Instructions

Getting Started

Network Connections

Listening to Audio Content
Over Your Home Network

Enjoying Sony
Multiple-Room Products

Others

Troubleshooting

WARNING

To reduce the risk of fire or electric shock, do not expose this apparatus to rain or moisture.

To reduce the risk of fire, do not cover the ventilation opening of the apparatus with newspapers, tablecloths, curtains, etc.

Do not place the naked flame sources such as lighted candles on the apparatus.

Do not install the appliance in a confined space, such as a bookcase or built-in cabinet.

To reduce the risk of fire or electric shock, do not expose this apparatus to dripping or splashing, and do not place objects filled with liquids, such as vases, on the apparatus.

As the main plug is used to disconnect the unit from the mains, connect the unit to an easily accessible AC outlet. Should you notice an abnormality in the unit, disconnect the main plug from the AC outlet immediately.

Do not expose batteries or apparatus with battery-installed to excessive heat such as sunshine, fire or the like.

The unit is not disconnected from the mains as long as it is connected to the AC outlet, even if the unit itself has been turned off.

CAUTION

Danger of explosion if battery is incorrectly replaced. Replace only with the same or equivalent type.

The dating code and the nameplate are located on the bottom exterior.

Replace the battery with a Sony CR2025 lithium battery.

Use of another battery may present a risk of fire or explosion.

For customers in the United States and Canada

Owner's Record

The model and serial numbers are located on the bottom of the unit. Record these numbers in the space provided below. Refer to them whenever you call upon your Sony dealer regarding this product.
Model No. _____ Serial No. _____

For customers in the United States

Important Safety Instructions

- 1) Read these instructions.
- 2) Keep these instructions.
- 3) Heed all warnings.
- 4) Follow all instructions.
- 5) Do not use this apparatus near water.
- 6) Clean only with dry cloth.
- 7) Do not block any ventilation openings. Install in accordance with the manufacturer's instructions.
- 8) Do not install near any heat sources such as radiators, heat registers, stoves, or other apparatus (including amplifiers) that produce heat.
- 9) Do not defeat the safety purpose of the polarized or grounding-type plug. A polarized plug has two blades with one wider than the other. A grounding type plug has two blades and a third grounding prong. The wide blade or the third prong are provided for your safety. If the provided plug does not fit into your outlet, consult an electrician for replacement of the obsolete outlet.
- 10) Protect the power cord from being walked on or pinched particularly at plugs, convenience receptacles, and the point where they exit from the apparatus.
- 11) Only use attachments/accessories specified by the manufacturer.

- 12) Use only with the cart, stand, tripod, bracket, or table specified by the manufacturer, or sold with the apparatus. When a cart is used, use caution when moving the cart/apparatus combination to avoid injury from tip-over.



- 13) Unplug this apparatus during lightning storms or when unused for long periods of time.
- 14) Refer all servicing to qualified service personnel. Servicing is required when the apparatus has been damaged in any way, such as power-supply cord or plug is damaged, liquid has been spilled or objects have fallen into the apparatus, the apparatus has been exposed to rain or moisture, does not operate normally, or has been dropped.

The following FCC statement applies only to the version of this model manufactured for sale in the U.S.A. Other versions may not comply with FCC technical regulations.

NOTE:

This equipment has been tested and found to comply with the limits for a Class B digital device, pursuant to Part 15 of the FCC Rules. These limits are designed to provide reasonable protection against harmful interference in a residential installation. This equipment generates, uses and can radiate radio frequency energy and, if not installed and used in accordance with the instructions, may cause harmful interference to radio communications. However, there is no guarantee that interference will not occur in a particular installation. If this equipment does cause harmful interference to radio or television reception, which can be determined by turning the equipment off and on, the user is encouraged to try to correct the interference by one or more of the following measures:

- Reorient or relocate the receiving antenna.
- Increase the separation between the equipment and receiver.
- Connect the equipment into an outlet on a circuit different from that to which the receiver is connected.
- Consult the dealer or an experienced radio/TV technician for help.

CAUTION

You are cautioned that any changes or modifications not expressly approved in this manual could void your authority to operate this equipment.

The shielded interface cable recommended in this manual must be used with this equipment in order to comply with The limits for a digital device pursuant to Subpart B of Part 15 of FCC Rules.

This device complies with Part 15 of the FCC Rules. Operation is subject to the following two conditions: (1) this device may not cause harmful interference, and (2) this device must accept any interference received, including interference that may cause undesired operation.

This equipment must not be co-located or operated in conjunction with any other antenna or transmitter.

This equipment complies with FCC radiation exposure limits set forth for uncontrolled equipment and meets the FCC radio frequency (RF) Exposure Guidelines in Supplement C to OET65.

This equipment should be installed and operated with at least 20cm and more between the radiator and person's body (excluding extremities: hands, wrists, feet and ankles).

Operation is subject to the following two conditions: (1) this device may not cause interference, and (2) this device must accept any interference, including interference that may cause undesired operation of this device.

This equipment complies with IC radiation exposure limits set forth for uncontrolled equipment and meets the RSS-102 of the IC radio frequency (RF) Exposure rules.

This equipment should be installed and operated with at least 20cm and more between the radiator and person's body (excluding extremities: hands, wrists, feet and ankles).

**For the State of California,
USA only**

Perchlorate Material - special handling may apply.

See

www.dtsc.ca.gov/hazardouswaste/perchlorate

Perchlorate Material: Lithium battery contains perchlorate.

Table of Contents

Features of this unit	6
Product Overview	7

Getting Started

Guide to Parts and Controls	8
Main unit	8
Remote control	11
Checking the Supplied Accessories	12
Preparing the Unit and the Remote	12
Connecting to an AC power source	12
Preparing the remote control	12
Turning the Unit On or Off	13

Network Connections

How to Connect Your Network	14
Setting Up Wireless Networks	14
Option 1: Manual wireless setup	14
Setting Up Wireless Networks Using an Access Point Compliant with WPS	16
Option 2: WPS push button configuration method	16
Option 3: PIN method	17
Setting Up Wired Networks	18
Option 4: DHCP method	18
Option 5: Fixed IP method	18

Listening to Audio Content Over Your Home Network

Using DLNA (Digital Living Network Alliance)	20
Listening to audio content on a computer with Windows 7	20
Listening to audio content on a computer with Windows Vista/ Windows XP	22
Listening to audio content on a server	23
Playing Back Audio Content on a Server at Random	23

Using the Bookmark Function	24
Registering a bookmark list	24
Playing back audio content in the bookmark list	24

Enjoying Sony Multiple-Room Products

Using the PARTY STREAMING Function	25
Starting a PARTY	25
Joining a PARTY	26
Connecting the Unit with DLNA-compliant Devices	26
Enjoying audio content on a server using a controller	26

Others

Setting Screen on the Browser	27
Using the setting screen on the browser	27
Starting the browser with Windows XP	28
Specifications	29
Precautions	30
Glossary	31

Troubleshooting

Troubleshooting	33
-----------------------	----

Features of this unit

You can enjoy music from anywhere in your home by connecting this DLNA (Digital Living Network Alliance)-compliant unit to a network. For example, you can play back audio content stored on the computer in the bedroom, using this unit in the living room (page 20).

PARTY STREAMING function

PARTY STREAMING allows you to play back the same audio content with other devices having to the PARTY STREAMING function at the same time (page 25).

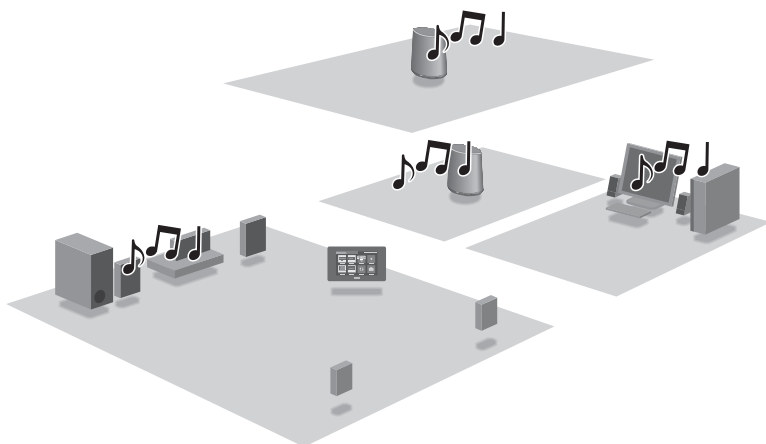

360-degree omni-sound

360-degree omni-sound enables you to enjoy high quality sound anywhere in the room.

Using this unit offline

You can use this unit as a normal active speaker when you connect your portable audio player to the AUDIO IN terminal of this unit (page 10).

Product Overview

1: Setting up your home network

Refer to the following pages according to your network environment.

Wireless networks

- ➔ Set up your network using the supplied CD-ROM. Refer to the leaflet “Preparations for listening to music via your home network” for details. Refer to page 14 when you set up your network manually.

WPS* compliant wireless networks

- ➔ Page 16

Wired networks

- ➔ Page 18

* WPS is a standard for easy and secure establishment of a wireless home network. Many new wireless LAN router/access point come with this feature.

2: Listening to the music from a server

You need a DLNA-compliant digital media controller (not supplied) to find your favorite music content on your server (computer, etc.), and send them to play on this unit. For details, refer to page 20.

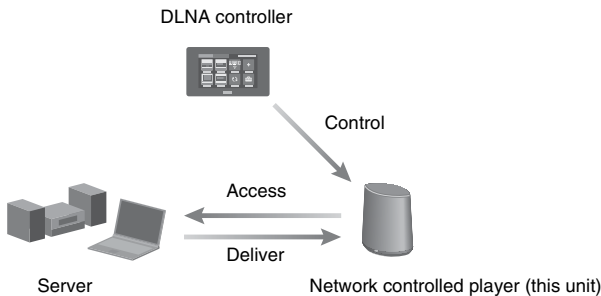

You can enjoy audio content using only this unit and a computer by using the computer as both server and controller. Windows 7 has to be installed on your computer to use this function. For details, refer to page 20.

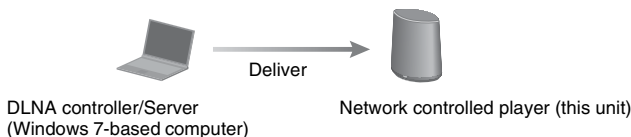

Guide to Parts and Controls

Main unit

Front

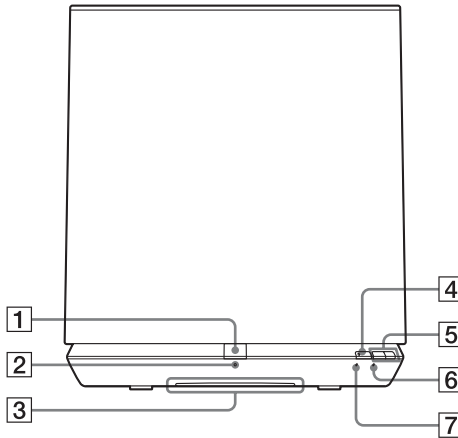

1 PARTY button

Press to use the PARTY STREAMING function (page 25).

Tip

This button also receives signals from a remote control.

Operate the remote control aiming at this point. The remote signal reception of this unit may not work correctly when the surface of this button is dirty.

2 PARTY STREAMING indicator

Indicates the PARTY STREAMING status (page 25).

Green: The unit is having a PARTY as PARTY host.

Amber: The unit has joined a PARTY as PARTY guest.

Red: An error has occurred.

3 Illumination indicator

Indicates the playback status of audio content.

White: The unit is in playback mode.

Blue: The unit has stopped playing back audio content.

Note

This indicator normally lights up in white even if the unit stops playing when audio input is selected.

4 AUDIO IN button/indicator

Press to switch the input between the home network and the audio input.

Lights up in green when the audio input is selected.

This indicator goes off when the unit connects to your home network (with either a wireless or wired connection).

5 VOL+/- buttons

Use to adjust the volume. The illumination indicator flashes when the volume level is set to either minimum or maximum.

6 NETWORK STANDBY indicator

Lights up in amber when the unit is in the network standby mode (page 13).

7 LINK indicator

Indicates the connection status of the wired/wireless LAN.

Green: Wireless connection (page 14).

Amber: Wired connection (page 18).

Red: The following status have occurred.

- This unit cannot find the wireless LAN access point.
- The security method/password selected for the access point is wrong.
- An error has occurred.

Not lit: The wireless network setting process is not finished.

Rear

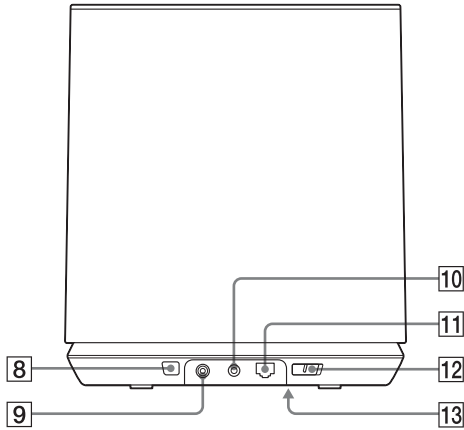

8 WPS button

Use to make the network settings for the WPS push button configuration (page 16).

9 DC IN terminal

Use to connect the supplied AC adaptor (page 12).

10 AUDIO IN terminal

Use to connect the audio output jack of an external component.

11 (LAN) port

Use to connect the network (LAN) cable.

12 Power switch

Slide the switch to turn the power on or off.

Note

You cannot operate this unit via a home network when the power switch is set to OFF. Set the unit to the network standby mode when you want to operate the unit via a home network. Refer to “To set the network standby mode” (page 13).

13 ALL RESET button

Press and hold for more than three seconds to reset the unit to its factory default settings when the power switch is set to ON.

Use a thin object, such as a small pin. The bookmark list (page 24) and any other previously registered settings or information will be reset.

Note

Network settings are also reset when you press ALL RESET button.

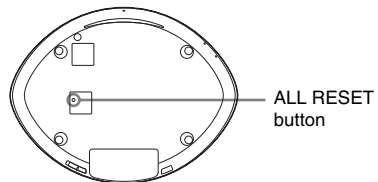

Remote control

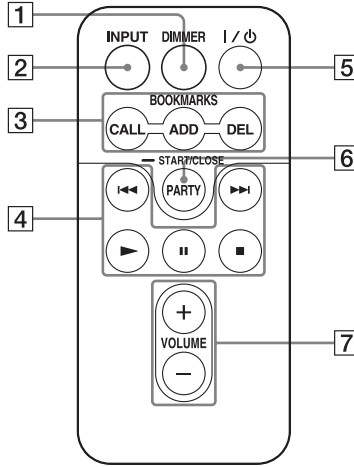

1 DIMMER button

Press to change the brightness of the illumination indicator (normal/dark).

2 INPUT button

Press to change the input between the home network and the audio input.

3 BOOKMARKS buttons

Use for the bookmark function (page 24).

CALL button

Press to play back the audio content in the bookmark list.

ADD button

Press to add audio content to the bookmark list.

DEL button

Press to delete audio content from the bookmark list.

4 Operation buttons

▶▶▶ button*: Skip to the next audio content item.

◀◀◀ button*: Back to the previous audio content item.

▶/||*/■ button: Start/pause/stop playback.

* These buttons may not work depending on the device or the function you are using.

5 I/⏻ (power) button

Press to switch between power on and network standby mode.

6 PARTY button

Press to use the PARTY STREAMING function (page 25).

7 VOLUME buttons

Press to adjust the volume.

Checking the Supplied Accessories

Remote control (1)
AC adaptor (1)
AC power cord (1)
Operating Instructions (this manual) (1)
Preparations for listening to music via your home network (Leaflet) (1)
Network (LAN) cable (1)
CD-ROM (“Network Speaker Wi-Fi Utility”) (1)

Preparing the Unit and the Remote

Connecting to an AC power source

- 1** Connect the AC power cord to the AC adaptor.
- 2** Plug the connector of the AC adaptor into the DC IN terminal on the unit.

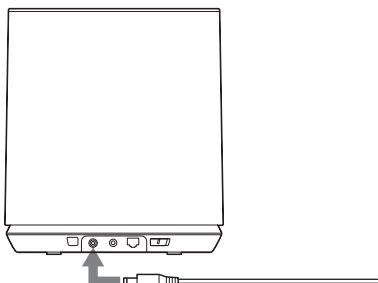

- 3** Plug the AC power cord to a wall outlet (the mains).

Preparing the remote control

The supplied lithium battery (CR2025) has already been inserted into the remote control. Pull out the protective sheet before use.

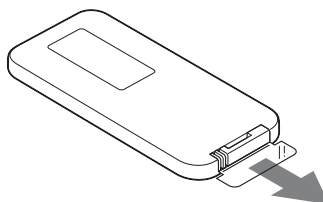

Replacing the battery of the remote control

If the remote control stops working, replace the battery (CR2025) with a new one.

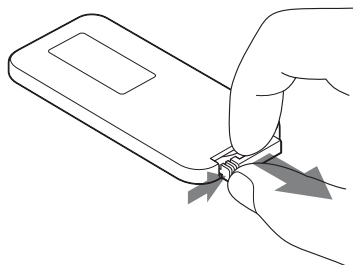

- 1** Pull out the battery holder.
- 2** Remove the old battery from the battery holder and then insert a new battery.
- 3** Reinsert the battery holder into the remote control.

Turning the Unit On or Off

Slide the power switch to ON

The NETWORK STANDBY indicator lights up in amber and the illumination indicator lights up in blue.

You can operate this unit when the NETWORK STANDBY indicator goes off and the illumination indicator lights up. It may take a while.

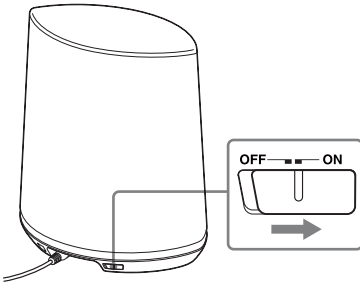

Note

Keep this unit in the network standby mode so it can be controlled from a controller even when you are not currently operating this unit. (Refer “To set the network standby mode”.)

To set the network standby mode

Press I/⏻ on the remote.

The NETWORK STANDBY indicator lights up in amber.

Tip

The unit can be controlled from the controller on your network, etc., when the unit is in the network standby mode. The unit turns on automatically when the controller delivers audio content to this unit.

To resume power from the network standby mode

Press I/⏻ on the remote.

The illumination indicator lights up.

To turn the unit off

Slide the power switch to OFF when you need to turn the unit off, such as when disconnecting the AC power cord, etc.

Tip

You cannot operate this unit via a home network when the power switch is set to OFF but you can reduce the power consumption.

How to Connect Your Network

Set up the network after checking your network environment. Refer to the following descriptions.

Wireless Network:

Set up your network using the supplied CD-ROM. Refer to the leaflet “Preparations for listening to music via your home network” for details.

Refer to option 1 when you set up your network manually.

- Option 1: Manual wireless setup

WPS Compliant Wireless Network:

- Option 2: WPS push button configuration method (page 16)
- Option 3: PIN method (page 17)

Wired network:

- Option 4: DHCP method (page 18)
- Option 5: Fixed IP method (page 18)

Tip

You can set up a wireless network using a fixed IP address. Refer to the instructions for a wired network (page 18).

When a problem occurs while you are making the network settings

Press ALL RESET button on the bottom of the unit with a pointed object (such as a small pin) (page 10).

Setting Up Wireless Networks

Option 1: Manual wireless setup

Your computer must be connected to the wireless LAN router/access point in advance. Write down important information such as the SSID and security method, etc. of your wireless LAN router/access point. Refer to the operating instructions of the router.

SSID	
Security method	
Security key (WEP/WPA key, etc.)	

- 1 Check whether your computer and wireless LAN router/access point are turned on.**
- 2 Connect the unit and the wireless LAN router/access point using a network (LAN) cable.**

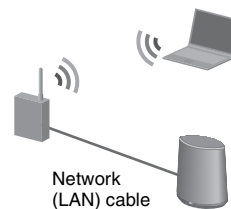

- 3 Turn the unit on.**
- 4 Click [My Network] or [Network] → [SA-NS400].**

The [Sony Network Device Setting] screen appears.

Notes

- Install the UPnP service in advance if you are using Windows XP (page 28).
- Refer to “Setting Screen on the Browser” (page 27) for details on the display of [My Network] or [Network].
- Check your set-up of the firewall of the security software if you cannot find [SA-NS400] or the browser does not open even if you double-click [SA-NS400] on screen of your computer.
- Restart your computer if you cannot find [SA-NS400].

5 Select the desired language when the “Language Setup” screen appears.

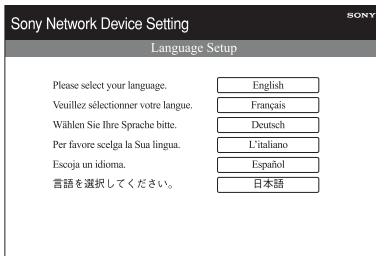

6 Select [Network Settings] from the menu.

7 Enter the SSID of your access point, then select the security method.

Enter the SSID and Security Method. Refer to the memo that you wrote for this information (page 14). Enter Security key (WEP/WPA key, etc.) if you selected anything other than [No Security] as a security method.

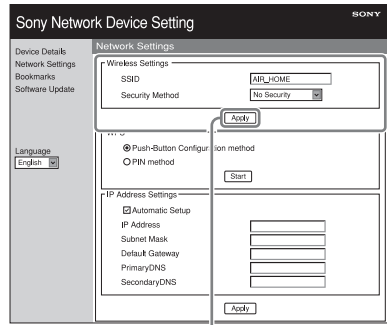

Apply

Note

You cannot input the following characters.
: / ? # [] @ ! \$ & ' () * + , ; = " %

8 Click [Apply].

9 Click [OK] when the confirmation screen of the pop-up window appears.

10 Disconnect the unit and the wireless LAN router/access point following the on-screen instructions.

The unit restarts automatically, then the LINK indicator lights up in green when the connection is made.

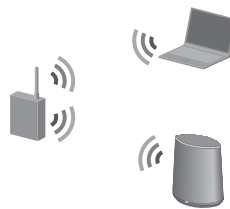

Tip

Refer to the operating instructions for details on the access point.

About wireless LAN security

Since communication via the wireless LAN function is established by radio waves, the wireless signal may be susceptible to interception. To protect wireless communication, this system supports various security functions. Be sure to correctly configure the security settings in accordance with your network environment.

No Security

Although you can easily make settings, anyone can intercept wireless communication or intrude into your wireless network, even without any sophisticated tools. Keep in mind that there is a risk of unauthorized access or interception of data.

WEP

WEP applies security to communications to prevent outsiders from intercepting communications or intruding into your wireless network. WEP is a legacy security technology that enables older devices, which do not support TKIP/AES, to be connected.

WPA-PSK (TKIP), WPA2-PSK (TKIP)

TKIP is a security technology developed to correct for the deficiencies of WEP. TKIP assures a higher security level than WEP.

WPA-PSK (AES), WPA2-PSK (AES)

AES is a security technology that uses an advanced security method that is distinct from WEP and TKIP. AES assures a higher security level than WEP or TKIP.

Setting Up Wireless Networks Using an Access Point Compliant with WPS

Option 2: WPS push button configuration method

1 Check whether the network (LAN) cable is disconnected.

Disconnect the network (LAN) cable after sliding the power switch to OFF if the network (LAN) cable is connected.

2 Turn the unit on.

You can operate this unit when the NETWORK STANDBY indicator goes off and the illumination indicator lights up. It may take a while.

Note

Make sure the home network input is selected.

3 Press the WPS button on the access point.

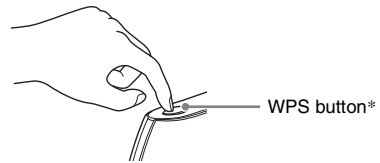

* The position and the shape of the WPS button are different depending on the model of the access point.

Tip

Refer to the operating instructions of your wireless LAN router/access point for details on the WPS button.

4 Press the WPS button on the unit for three seconds.

The LINK indicator lights up in green when the connection is made.

Option 3: PIN method

Your computer must be connected to the wireless LAN router/access point in advance. Write down the SSID of your wireless LAN router/access point.

SSID	

Refer to the operating instructions of the access point.

1 Check whether your computer and wireless LAN router/access point are turned on.

2 Connect the unit and the wireless LAN router/access point using a network (LAN) cable.

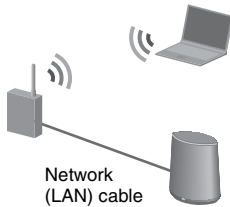

3 Turn the unit on.

4 Click [My Network] or [Network] → [SA-NS400].

The [Sony Network Device Setting] screen appears.

Notes

- Install the UPnP service in advance if you are using Windows XP (page 28).
- Refer to “Setting Screen on the Browser” (page 27) for details on the display of [My Network] or [Network].
- Check your set-up of the firewall of the security software if you cannot find [SA-NS400] or the browser does not open even if you double-click [SA-NS400] on screen of your computer.
- Restart your computer if you cannot find [SA-NS400].

5 Select the desired language when the “Language Setup” screen appears.

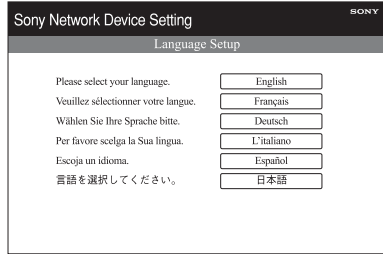

6 Select [Network Settings] from the menu.

7 Enter the SSID of your access point.

Enter the SSID. Refer to the memo that you wrote for this information.

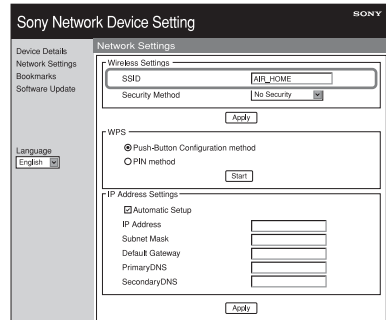

8 Select [PIN method], then click [Start].

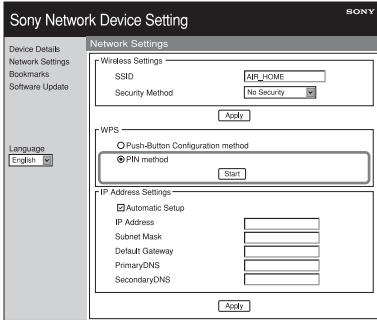

An eight-digit number (PIN code) appears on the screen.

9 Enter the unit's PIN code in the wireless LAN router/access point.

Tip

Refer to the operating instructions for details on the wireless LAN router/access point.

10 Click [OK] on the PIN code screen that is displayed in step 8.

Disconnect the network (LAN) cable, etc., following the on-screen instructions. The unit restarts automatically, then the LINK indicator lights up in green when the connection is made.

Note

Perform the process again from step 1 when the LINK indicator flashes in red.

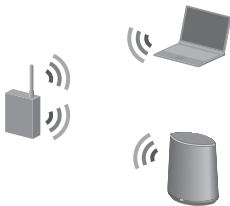

Tip

You can also select the WPS push button configuration method in step 8.

Setting Up Wired Networks

Option 4: DHCP method

Usually, the DHCP setting is set to ON when you connect your computer to the network. Try the following method if you are using a wired network.

Set the DHCP setting of your computer to ON in advance.

- 1 Check whether your computer and router are turned on.
- 2 Connect the unit and the router using a network (LAN) cable.
- 3 Connect the router and your computer using a second network (LAN) cable.

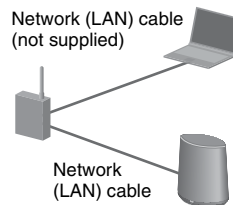

4 Turn the unit on.

The LINK indicator lights up in amber when the connection is made.

Option 5: Fixed IP method

Your computer must be connected to the router in advance.

- 1 Set the DHCP setting of your computer and the router to ON.
- 2 Connect the router and the unit using a network (LAN) cable.

- 3 Check whether your computer and router are turned on.
- 4 Turn the unit on.
- 5 Click [My Network] or [Network] → [SA-NS400].

The [Sony Network Device Setting] screen appears.

Notes

- Install the UPnP service in advance if you are using Windows XP (page 28).
- Check your set-up of the firewall of the security software if you cannot find [SA-NS400] or the browser does not open even if you double-click [SA-NS400] on screen of your computer.
- Restart your computer if you cannot find [SA-NS400].

- 6 Select the desired language when the “Language Setup” screen appears.

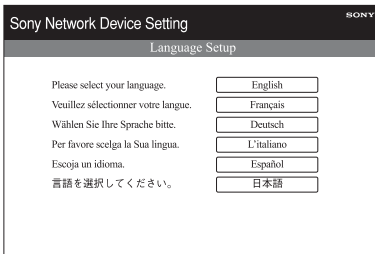

- 7 Select [Network Settings] from the menu.

- 8 Remove the checkmark in the check box beside [Automatic Setup], then input the required information for each item.

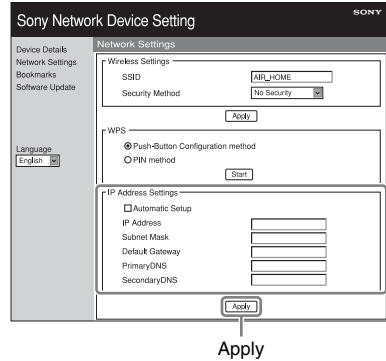

- IP address (IP address of the unit)
- Subnet Mask (Subnet Mask)
- Default Gateway (Default Gateway)
- PrimaryDNS (IP address of the primary DNS)
- SecondaryDNS (IP address of the Secondary DNS)

- 9 Click [Apply].
- 10 Click [OK] when the confirmation screen of the pop-up window appears.

The unit restarts automatically, then the LINK indicator lights up in amber when the connection is made.

Note

Set the DHCP setting of your computer and router to OFF again.

Listening to Audio Content Over Your Home Network

Using DLNA (Digital Living Network Alliance)

You can play back audio content on DLNA-compliant servers such as your computer, or network audio, etc, on this unit. A DLNA-compliant controller device (a remote control device, etc.) is needed for the operation.

You can use Windows 7 as both server and controller.

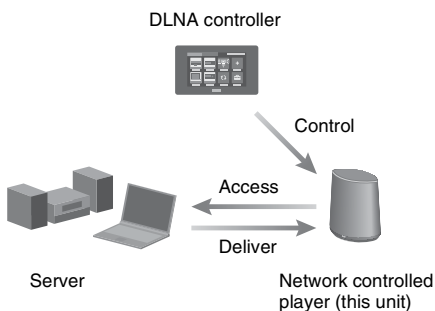

The unit can play audio content stored on the server in MP3, Linear PCM, WMA and AAC* formats. Audio content with DRM (Digital Rights Management) copyright protection cannot be played on this unit.

*The unit can play AAC files with the extension of “.m4a,” “.mp4,” or “.3gp” only.

Notes

- Generally, it may take a while to recognize each DLNA-compliant device currently used when you enjoy audio content via a home network.
- This unit cannot playback files in WMA format with DRM copyright protection. If a WMA file cannot be played back on this unit, check the property of that file on your computer, and see whether the file is DRM-copyrighted. Open a folder or a volume where the WMA file is stored, and right-click the file to display the [Property] window. When there is the [Licence]

tab, the file is DRM-copyrighted and cannot be played back on this unit.

- You may not be able to play back some content with DLNA CERTIFIED products.

Listening to audio content on a computer with Windows 7

Windows 7 supports DLNA1.5. Windows 7 can be used as both server and controller. You can listen to audio content on the server easily using the [Play To] function of Windows 7.

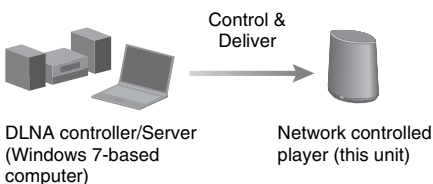

Note

The items displayed on the computer may be different from the ones shown in this section, depending on the version of the operating system or the computer environment. For details, refer to the help of your operating system.

Setting up a computer with Windows 7

- 1 Go to [Start] - [Control Panel] and select [View network status and tasks] under [Network and Internet]. The [Network and Sharing Center] window appears.

Tip

If the desired item does not appear in the display, try to change the display type of the Control Panel.

- 2** Select [Public network] under [View your active networks]. If the display shows other than [Public network], go to step 5.

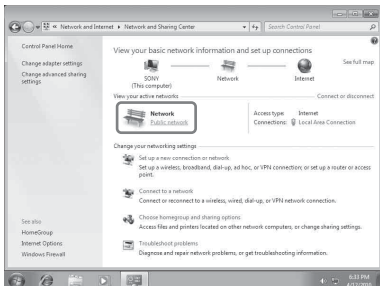

- The [Set Network Location] window appears.
- 3** Select [Home network] or [Work network] according to the environment in which the speaker is used.
- 4** Follow the instructions that appear on the display according to the environment in which the speaker is used. When the change is completed, confirm that the item under [View your active networks] has been changed to [Home network] or [Work network] in the [Network and Sharing Center] window.
- 5** Select [Change advanced sharing settings].

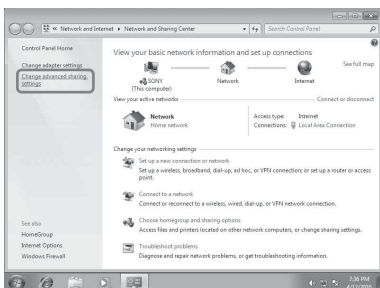

- 6** Select [Choose media streaming options...] from [Media streaming].

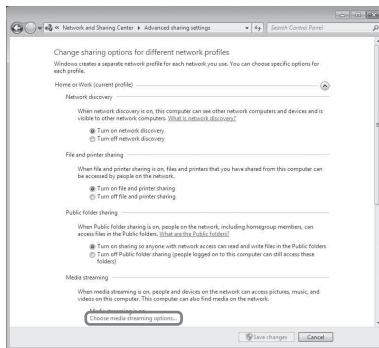

- 7** If [Media streaming is not turned on] appears in the Media streaming options window, select [Turn on media streaming].
- 8** Select [Allow All].

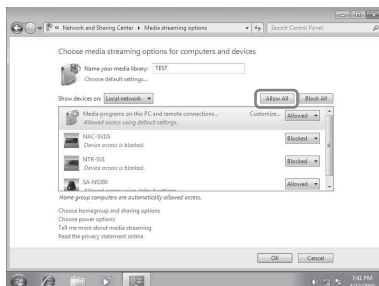

- The [Allow all media devices] window opens. If all the devices in the local network are [Allowed] to access your network, select [OK] and close the window.
- 9** Select [Allow all computers and media devices].
- 10** Select [OK] to close the window.

Listening to audio content stored on a computer with Windows 7

- 1 Start [Windows Media Player] of Windows 7.
- 2 Turn on media streaming.
- 3 Select the desired audio content, then click the right mouse button.

4 Select [Play To] from the menu.

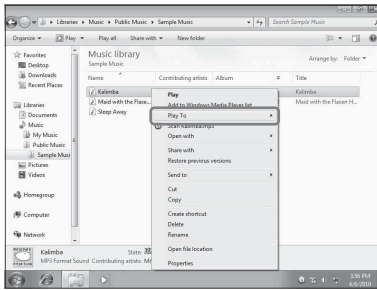

The device list appears.

5 Select [SA-NS400].

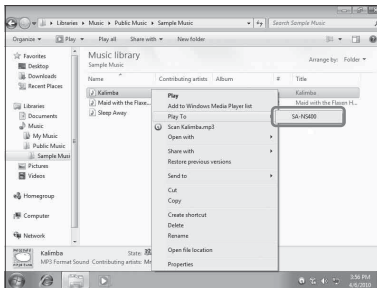

The audio content is played back from this speaker.

Listening to audio content on a computer with Windows Vista/ Windows XP

You need to set up Windows Media Player 11 to listen to the music using the Windows Vista/ Windows XP* as a server.

* Windows Media Player 11 is not manufacturer-installed on Windows XP. Access the Microsoft web site, download the installer, and then install Windows Media Player 11 on your computer.

Note

The items displayed on the computer may be different from the ones shown in this section, depending on the version of the operating system or the computer environment. For details, refer to the help of your operating system.

Setting up a computer with Windows Vista/ Windows XP

1 Go to [Start] - [All Programs] and select [Windows Media Player].

Windows Media Player 11 starts up.

2 Select [Media Sharing...] from the [Library] menu.

If you are using Windows XP, go to step 8.

3 When  is displayed, select [Networking...].

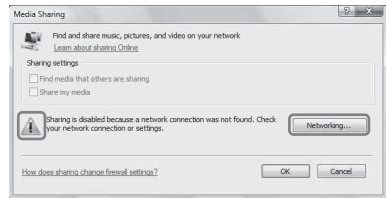

The [Network and Sharing Center] window appears.

4 Select [Customize].

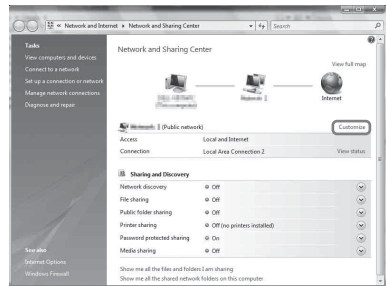

The [Set Network Location] window appears.

5 Add a check next to [Private] and select [Next].

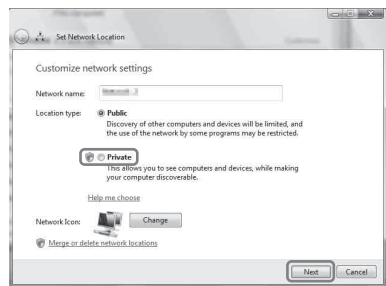

- 6 Confirm that the [Location type] has been changed to [Private] and select [Close].
- 7 Confirm that [(Private network)] is displayed in the [Network and Sharing Center] window and close the window.
- 8 If a check is not added next to [Share my media] in the [Media Sharing] window that is displayed in step 2, add a check next to [Share my media], then select [OK].



A list of connectable devices is displayed.

- 9 Select [Settings...] that appears beside [Share my media to:].
- 10 Add a check next to [Allow new devices and computers automatically] and select [OK].

Note

Uncheck this item after you confirm that the unit can connect to the computer and play audio data on the computer.

Listening to audio content stored on a computer with Windows Vista/ Windows XP

There are two methods to listen to audio content on a computer with the Windows Vista/ Windows XP.

- Using the DLNA controller (page 20)
- Random playback

Listening to audio content on a server

The operation is different depending on the device. Refer to the operating instructions of your server or controller.

Playing Back Audio Content on a Server at Random

You can play back audio content on the server which is recognized first. You can use this function without a controller.

Notes

- This function is available only with computers that have Windows Media Player 11/12 or VAIO Media plus 1.3 (or later) installed.
- Close any DLNA controller functions or devices, such as the [Play To] dialogue of Windows Media Player 12, when you want to play back audio content from a server at random.

1 Press INPUT on the remote to select home network input.

You can also use the AUDIO IN button on the unit.

2 Press ► on the remote.

Audio content is played back only at random on the server which is recognized first.

Using the Bookmark Function

This function allows you to play back only audio content that is bookmarked. You need to register audio content while it is being played back on this unit in the bookmark list. You can register audio content which is being played back via the network on the server in your bookmark list.

Registering a bookmark list

- 1 Select the home network input.**
- 2 Press BOOKMARKS ADD on the remote when you play back the desired audio content.**

The illumination indicator flashes.

Deleting from the bookmark list

Press BOOKMARKS DEL on the remote when you are playing back or have paused the audio content you want to delete.

The illumination indicator flashes.

Tip

You can delete audio content currently being played back while using the bookmark list.

Notes

- You can register up to 30 audio content items in the bookmark list.
- You cannot register the same audio content two or more times in a row.

Playing back audio content in the bookmark list

- 1 Select the home network input.**
- 2 Press the BOOKMARKS CALL button on the remote.**

The illumination indicator lights up in white.

Notes

- You cannot play back audio content using the Bookmark function when the bookmark list is empty.
- Close any DLNA controller functions or devices, such as the [Play To] dialogue of Windows Media Player 12, when you want to play back audio content using a bookmark list.

To manage the bookmark list

The operation must be carried out using the browser. Refer to “Bookmarks screen” (page 28).

Enjoying Sony Multiple-Room Products

Using the PARTY STREAMING Function

You can play back audio content that is being played back on this unit or on another device that has a PARTY STREAMING function at the same time, via your home network.

While using the PARTY STREAMING function, the device that starts a PARTY and streams the audio content is called the “PARTY host,” and the device that joins a PARTY and plays the audio content streamed from the PARTY host is called a “PARTY guest.”

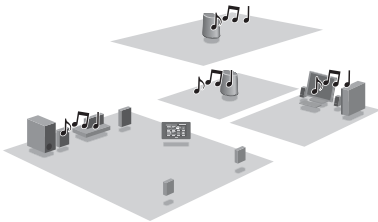

You can enjoy the PARTY STREAMING function with other devices that have this PARTY STREAMING logo.

PARTY STREAMING in a wireless LAN environment

With some IEEE802.11n-compatible wireless LAN routers/access points, the wireless LAN transfer speed may slow down when “WEP” or “WPA/WPA2-PSK (TKIP)” is selected for the security method.

If the sound skips during streaming playback using the PARTY STREAMING function, try changing the security method to “WPA/

WPA2-PSK (AES).” This may improve the transfer speed and the streaming playback. Configurations of encryption (security) vary depending on the model; please refer to the operating instructions supplied with your router/access point.

You can also obtain support information about wireless LAN settings on the following website.

<http://www.sony.net/audio/netsettings>

Starting a PARTY

You can start a PARTY so that other devices which support the PARTY STREAMING function can play the same music even though they are in different rooms.

- 1 Make sure the PARTY guest devices are turned on and are in a status which allows them to join a PARTY.**
- 2 Play back audio content using the AUDIO IN terminal or audio content stored on the server on your network on this unit.**
- 3 Press and hold PARTY for a few seconds.**

The unit starts PARTY STREAMING and the PARTY STREAMING indicator lights up in green.

To close a PARTY

Press and hold PARTY for a few seconds. The PARTY STREAMING indicator goes off.

Notes

- An error has occurred when the PARTY STREAMING indicator lights up in red. Perform the process from step 1 again.
- You cannot start a PARTY while you are currently participating in a PARTY.
- The ◀◀ and ▶▶ buttons may not work, depending on the server or audio content.
- If the PARTY button is pressed on another device that complies with the PARTY STREAMING

function while the unit is playing a track, the unit will start a PARTY as a PARTY host and the other device will join a PARTY as a PARTY guest.

Joining a PARTY

The unit can join a PARTY which has been started by another device so that you can enjoy the same audio content as that being played in a different room.

When another device (PARTY host) is having a PARTY, press PARTY.

The unit joins the PARTY as a PARTY guest and the PARTY STREAMING indicator lights up in amber.

To leave a PARTY

Press PARTY.

The PARTY STREAMING indicator goes off.

Notes

- An error has occurred when the PARTY STREAMING indicator lights up in red. Perform the process from step 1 again.
- The PARTY STREAMING indicator lights up in amber when other devices utilizing the PARTY STREAMING function invite this unit to a PARTY. When you want to leave that PARTY, press PARTY.
- You cannot join a PARTY in the following cases:
 - you have a PARTY on this unit
 - you have already joined in another PARTY
- If you press PARTY when no PARTY is being held, but a device that complies with the PARTY STREAMING function is playing, the device will be the PARTY host and the unit will join the PARTY as a PARTY guest.

To use the PARTY STREAMING function with a DLNA controller

You can use a DLNA controller that supports the PARTY STREAMING function to use the unit to start a PARTY that is being held by other devices.

Connecting the Unit with DLNA-compliant Devices

Enjoying audio content on a server using a controller

You can use DLNA Controller to control a server to stream audio content to this unit. To perform these operations, check the following first.

- Check that all devices are connected to your home network and set up correctly.
- Check that the unit and the server are turned on or the unit and the server are in the network standby - on mode.
- Check that the unit and the controller are allowed to access the server.
- Check that the unit and the server have been recognized and registered with the controller.

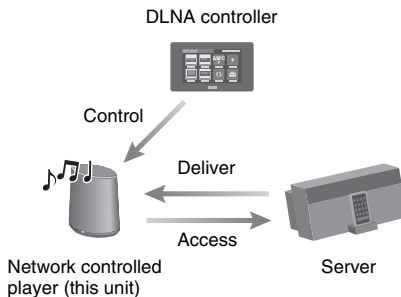

Setting Screen on the Browser

Start up the browser of the unit referring to the followings.

For Windows 7 users:

Double-click [Computer] on the desk top, then click [Network] on the left side of the screen. Double-click [SA-NS400]. Select the desired language after the “Language Setup” screen appears.

For Windows Vista users:

Click [Start] → [Network], and then double-click [SA-NS400]. Select the desired language after the “Language Setup” screen appears.

For Windows XP users:

Click [Start] → [My Network], and then double-click [SA-NS400]. Select the desired language after the “Language Setup” screen appears.

System requirements for the computer

- Compliant computer:
IBM PC/AT or compatible computers
- Operating systems:
Windows 7 Ultimate
Windows 7 Professional
Windows 7 Home Premium
Windows 7 Home Basic
Windows 7 Starter
Windows Vista Ultimate
Windows Vista Business
Windows Vista Home Premium
Windows Vista Home Basic

Windows XP Professional (other than 64 bit)
Windows XP Home Edition

- Suitable browsers
Internet Explorer 6, 7, 8

Using the setting screen on the browser

You can make the various settings of this unit using the setting screen on the browser.

Device Details screen

You can check the information on this unit.

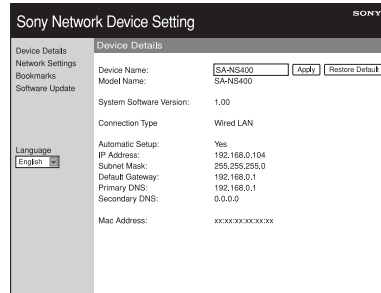

Network Settings screen

You can make the network settings using this screen.

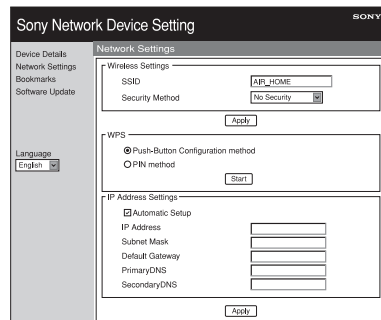

Bookmarks screen

You can manage the bookmark playlist using this screen.

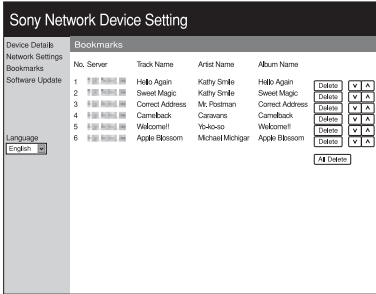

Software Update screen

You can update the firmware using this screen.

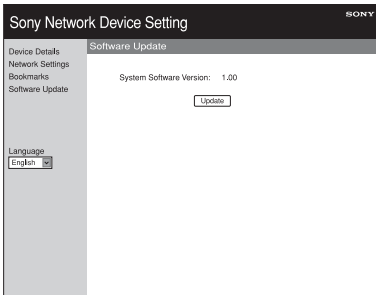

Tip

You can change the language using the language tab on the left side on the screen.

Starting the browser with Windows XP

You have to install the UPnP service for browsing.

Note

The items displayed on the computer may be different from the ones shown in this section, depending on the version of the operating system or the computer environment. For details, refer to the help of your operating system.

1 Click [Control Panel] → [Add or Remove Programs].

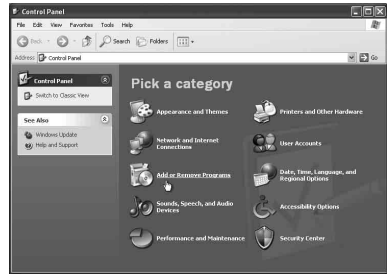

2 Click [Add/Remove Windows Components].

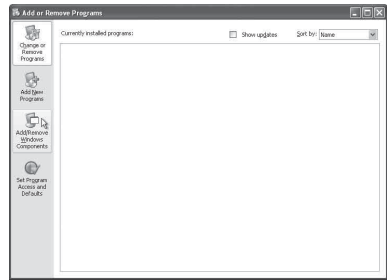

The Windows Components Wizard appears.

3 Click [Networking Services] → [Details...].

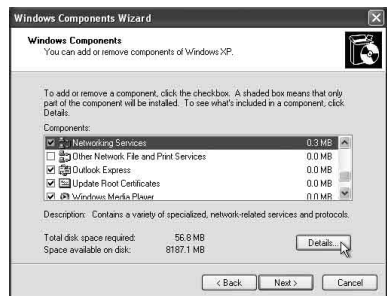

- 4** Put a check the checkbox beside [UPnP User Interface], then click [OK].

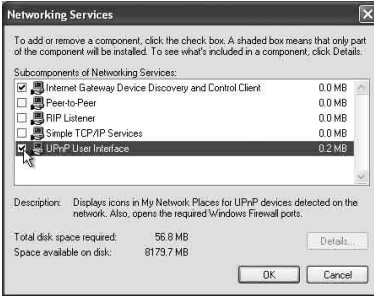

- 5** Click [Next].
The [Completing the Windows Components Wizard] window appears.

- 6** Click [Finish].



Specifications

AUDIO POWER SPECIFICATIONS

POWER OUTPUT AND TOTAL HARMONIC DISTORTION:

Satellite L+R

With 5 ohms loads, both channels driven, from 500 - 20 kHz;

rated 10 watts per channels minimum RMS power, with no more than 1 % total harmonic distortion from 1 watts to rated output.

Wireless LAN section

Compatible standards:

IEEE 802.11 b/g
(WEP 64 bit, WEP 128 bit,
WPA/WPA2-PSK (AES),
WPA/WPA2-PSK (TKIP))

Radio frequency:

2.4 GHz

Inputs/Outputs

Speakers

Approx. 110 mm (4 3/8 in) diameter × 1
Approx. 30 mm (1 3/16 in) diameter × 4

AUDIO IN jack:

Stereo mini jack
Voltage: 1.0 V

Network port:

10BASE-T/100BASE-T (Auto Polarity)

General

Power requirements:

AC adaptor
Input: 120-240V AC, 50/60Hz
Output: DC18V 2.6A

Dimensions (w/h/d) (including projecting parts and controls):

Approx. 240 × 273 × 185 mm

(Approx. 9 1/2 × 10 3/4 × 7 3/8 in)

Mass

Approx. 3.9 kg (8 lb 10 oz)

Supplied accessories:

See page 12.

Design and specifications are subject to change without notice.

Precautions

On safety

- Before operating the system, be sure that the operating voltage of the system is identical with that of your local power supply.

Where purchased	Operating voltage
North America	120 V AC, 60 Hz
Europe	220-240 V AC, 50/60 Hz

- Use only the supplied AC adaptor and AC power cord.

On operation

- Do not open the cabinet. Refer servicing to qualified personnel only.
- Should any solid object or liquid fall into the system, have the system checked by qualified personnel before operating it any further.
- This system is not magnetically shielded, do not leave recorded tapes, watches, personal credit cards, or floppy disks with magnetic coding in front of the system for an extended period of time.
- Do not hold or grasp the cloth part of the front, when you carry this unit.

On placement

- Do not set the unit in an inclined position.
- Do not leave the unit in a location near heat sources, or in a place subject to direct sunlight, excessive dust, moisture, rain or mechanical shock.
- Do not place metal objects in front of the front panel. They may limit reception of radio waves.
- Do not place the system in a place where medical equipment is in use. It may cause a malfunction of medical equipment.

- If you use a pacemaker or other medical device, consult your physician or the manufacturer of your medical device before using the wireless LAN function.

On cleaning

- Wipe the unit using a soft cloth such as the cloths used for cleaning eye glasses, etc.
- Do not use alcohol, benzine, or thinner to clean the cabinet.

If the TV picture or monitor display is magnetically distorted

This speaker system is not magnetically shielded, and the picture on nearby TV sets may become magnetically distorted. In this situation, turn off the TV, wait 15 to 30 minutes, and turn it back on. If there is no improvement, move the speakers far away from the TV.

Glossary

■ Access Point (AP)

A specially configured network device on a wireless local area network (WLAN). Access points act as a central transmitter and receiver of WLAN signals.

■ DHCP

Abbreviation for Dynamic Host Configuration Protocol. A system for automatically allocating configuration data required for an Internet connection.

■ DLNA

Abbreviation for Digital Living Network Alliance. The DLNA is a nonprofit organization that establishes design guidelines for digital content shared over networks. For details, see <http://www.dlna.org/home/>

■ DNS

Abbreviation for Domain Name System. A server that translates domain names to IP addresses, or IP addresses to domain names. A DNS is identified by an IP address. Also called a “DNS server.”

■ IP address

IP addresses usually consist of four groups of up to three digits each, separated by a period (such as 192.168.239.1). All devices on a network must have an IP address.

■ LAN

Abbreviation for Local Area Network. LAN is a general name for networks set up for communication among devices including computers, printers, and fax machines in relatively small areas such as offices or buildings.

■ Network key (security key)

An encryption key used to limit the devices with which communication can occur. It is used to provide higher security for devices communicating via a wireless LAN router/access point.

■ Proxy

A program or a server that provides Internet access to computers within a firewall or quicker downloading of web pages.

■ Router

A device that bridges networks, converting the protocols and addresses of each network.

When connecting multiple network devices to the Internet, a router is necessary. The term “router” by itself may refer to any of these devices.

■ SSID

Abbreviation for Service Set Identifier. It is a name that identifies a particular access point within an IEEE 802.11 wireless LAN. To connect with an access point, a client device must be set with the same SSID. SSIDs can be up to 32 characters long. For higher security, a network key is normally also used. In this case, connection cannot occur unless the SSID matches the network key.

■ WEP

Abbreviation for Wired Equivalent Privacy.

An encryption key used in wireless LAN networks. As an IEEE standard based on RC4 algorithm cryptography, WEP is used to secure IEEE 802.11b wireless networks.

During the transmission of a message between a wireless LAN access point and a client device, the sending side encrypts the data and the receiving side decrypts it. For communication to occur, both devices must use a common code key, which is called the “WEP key.” The encryption level is indicated by the bit count of the key; e.g., 64 bits or 128 bits. The higher the bit count, the higher the security level.

■ WPA

Abbreviation for Wi-Fi Protected Access. An encryption standard for wireless LAN networks created by the Wi-Fi Alliance to remedy a number of serious security problems in the WEP system. In addition to the network name (SSID) and encryption key (WEP), this protocol uses a user authentication framework called “EAP” (Extensible Authentication Protocol) and a protocol called “TKIP” (Temporal Key Integrity Protocol) which automatically updates the encryption code at regular intervals for higher security.

■ WPA2

Abbreviation for Wi-Fi Protected Access 2. An encryption standard for wireless LAN networks. As an upgraded version of WPA created by the Wi-Fi Alliance, this standard uses AES (Advanced Encryption Standard) cryptography to provide stronger security than WPA.

■ WPS

Abbreviation for Wi-Fi Protected Setup. A wireless network standard created by the Wi-Fi Alliance to allow you to set up a wireless network easily. A push button configuration method and a PIN code method are available.

Troubleshooting

If a problem occurs while operating the unit, follow the steps described below before consulting your nearest Sony dealer. If an error message appears, it is recommended that you make a note of its contents for reference.

1 Check to see if the problem is listed in this “Troubleshooting” section.

2 Check the following customer support site.

<http://www.esupport.sony.com/>
You will find the latest support information and a FAQ at this web site.

3 If, after steps 1 and 2, you still cannot solve the problem, consult your nearest Sony dealer.

If the problem persists after doing all of the above, consult your nearest Sony dealer.

When bringing the product in for repairs, be sure to bring in the entire system (main unit, remote control, AC adaptor, and AC power cord).

This product is a system product, and so the entire system is needed to determine the section requiring repair.

Power

The unit does not turn on.

- Make sure the AC adaptor and AC power cord are connected correctly.
- Make sure the power switch is set to ON.
- Set the power switch to OFF, and then set it to ON again.

The NETWORK STANDBY indicator remains lit for a while after you set the power switch to ON.

- It takes about 20 seconds for the unit to turn on.

The unit remains warm after the power is turned off.

- When the unit is in the network standby mode, some parts of the internal system remain active. Slide the power switch to OFF to limit the power consumption to a minimum, however, the unit cannot be operated by a controller in such a case.

The unit turns on and starts playback automatically.

- The unit can be controlled by a controller. If the unit receives an order to play the audio content on the server while it is in the network standby mode, it turns on and starts playback automatically. To enter the network standby mode again, press the  (power) button on the remote. To prevent the unit from automatically turning on, slide the power switch to OFF.

The unit turns off automatically.

- The unit enters the network standby mode automatically if it is stopped for 30 minutes when the home network is selected.

Sound output

There is no sound.

- Press the VOLUME + button on the remote or press VOL+ button on the unit to turn up the volume. The unit may have been set to silence the sound by a controller. If the sound is output for a moment and then is silenced again, the unit may have received a command to silence the sound. Confirm the setting of the controller and release deleting the sound.
- When the PARTY STREAMING indicator lights up in amber, confirm the audio format of the audio content that is being played by the PARTY host. The unit stops playback when the PARTY host plays audio content with an audio format that cannot be played on the unit.

The sound skips.

- The sound may skip depending on the network environment, etc., when you use a wireless network.
- The servers are overloaded. Close all other applications you are currently using.

There is severe humming, noise, or sound distortion from the speakers.

- Connect the unit and other devices correctly. See page 10.

Network

The unit cannot connect to the network. (The unit cannot be found or recognized by other devices that are on the home network.)

- If you use the unit in a network environment without a router, it may take about a minute for the unit to obtain its IP address after you turn on the power.
- The IP address may be in use by another device when you use a fixed IP address. Use a different IP address in this case.

The unit cannot connect to the network via a wireless LAN connection.

- Make sure a network (LAN) cable is not connected to the unit. The unit automatically tries to connect to the network over a wired LAN connection when a network (LAN) cable is connected to the unit.
- Confirm that the access point (wireless LAN router) setting is correct. For details on the access point setting, refer to the operating instructions of the access point.

Browser

The browser screen does not appear.

- Check the proxy setting of the browser. This unit does not support proxies. Change the browser setting to one connecting this unit without a proxy.
- Check the set-up of the firewall of the security software. Refer to the web site (page 33) for details.

Home Network

The unit cannot be found from a controller. (The controller cannot browse the unit.)

- Check the set-up of the firewall of the security software. Refer to the web site (page 33) for details.
- Make sure the LINK indicator is lighting up in green or amber. Refer to “The unit cannot connect to the network. (The unit cannot be found or recognized by other devices that are on the home network.)” (page 34) if the LINK indicator goes off, flashes or lights up in red.
- Make sure the controller is connected to your home network.

Audio content has changed/started/stopped automatically.

- The unit may be under the control of another device. If you want to reject these requests, set the power switch of this unit to OFF.

The sound skips.

- The sound may skip depending on the network environment, etc., when you use a wireless network.
- The servers are overloaded. Close all unneeded applications you are currently using.

This unit cannot play back with this error indicated (illumination indicator (white) continues flashing quickly).

- Make sure that the audio content is not corrupted or has not been deleted from the server. Refer to the operating instructions of the server.
- The servers is trying to play back an unsupported audio format on this unit. Check the format information using the server.
- Deactivate the multicast control of your wireless LAN router/access point if it is activated. Refer to the operating manual of your wireless LAN router/access point for details.

This unit cannot play back with this indicated (illumination indicator (white) continues flashing).

- The server may not permit access from this unit. Change the settings of the server to permit access from this unit. Refer to the operating instructions of the server.

The **II (pause) button does not work.**

- The **II** (pause) button may not work, depending on the server.

BOOKMARKS

Refer to “Home Network” (page 34) if the problem does not apply to one of the following cases.

Playback does not start after pressing the BOOKMARKS CALL button.

- Make sure the LINK indicator is lighting up in green or amber. Refer to “The unit cannot connect to the network. (The unit cannot be found or recognized by other devices that are on the home network.)” (page 34) if the LINK indicator goes off, flashes or lights up in red.
- Make sure the AUDIO IN indicator is not lighting up. The BOOKMARKS CALL button does not work when the audio input is selected.
- The IP address of the server may have been changed if playback will not start when you press the BOOKMARKS CALL button. In this case, register the desired audio content again.

The unit does not register the playback audio content in the bookmark list when you press the BOOKMARKS ADD button.

- Make sure the PARTY STREAMING indicator is not lighting up in amber. The BOOKMARKS ADD button does not work when you have joined a PARTY.
- You cannot register the same audio content two or more times in a row.

Random play function

Refer to “Home Network” (page 34) if the problem does not apply to one of the following cases.

This unit does not play back.

- Make sure the LINK indicator is lighting up in green or amber. Refer to “The unit cannot connect to the network. (The unit cannot be found or recognized by other

devices that are on the home network.)” (page 34) if the LINK indicator goes off, flashes or lights up in red.

- This unit cannot play back audio content in the following case.
 - There is no server device.
 - There is no audio content that can be played back on the server.

PARTY STREAMING function

Refer to “Home Network” (page 34) if the problem does not apply to one of the following cases.

During a PARTY

This unit cannot join a PARTY.

- Make sure the LINK indicator is lighting up in green or amber. Refer to “The unit cannot connect to the network. (The unit cannot be found or recognized by other devices that are on the home network.)” (page 34) if the LINK indicator goes off, flashes or lights up in red.
- Make sure of the status of other PARTY guest. The unit cannot join a PARTY if other PARTY devices have all left the PARTY. Play back via another PARTY device when you join the PARTY as a PARTY guest.

If you want to start a PARTY as a PARTY host, press and hold PARTY for two seconds or more.

- Deactivate the multicast control of your wireless LAN router/access point if it is activated. Refer to the operating manual of your wireless LAN router/access point for details.

The unit takes a few minutes to connect to the PARTY host.

- Check the status of the PARTY STREAMING indicator. The PARTY has already closed if the PARTY STREAMING indicator goes off.

This unit is the PARTY host if the PARTY STREAMING indicator lights up in green. Play back the audio content.

Using this unit as a PARTY host

This unit cannot start a PARTY.

- Make sure the LINK indicator is lighting up in green or amber. Refer to “The unit cannot connect to the network. (The unit cannot be found or recognized by other devices that are on the home network.)” (page 34) if the LINK indicator goes off, flashes or lights up in red.

This unit cannot leave the PARTY.

- You cannot leave the PARTY while using this unit as a PARTY host.

Another device cannot join the PARTY that is being held on this unit.

- The number of PARTY guest exceeds the maximum number when the PARTY STREAMING indicator flashes green and red alternately. Remove one of the PARTY guest.

Others

The NETWORK STANDBY indicator flashes in amber.

- The system is in protect mode.
- Disconnect and reconnect the AC cord of the unit, then turn the unit on again. If the NETWORK STANDBY indicator still flashes, consult your nearest Sony dealer.

This unit does not work correctly.

- This unit is affected by static electricity, etc. Set the power switch to OFF, and then set it to ON again. Reset this unit if the unit does not work correctly.

This unit does not operate if you press the buttons of this unit or those of the remote.

- Buttons do not work during initializing or starting up.
- Buttons do not work while you are updating the software.
- Buttons other than the I/⏻ (power) button on the remote do not work in the network standby mode.

The remote does not work.

- There are inverter fluorescent lights near the unit. Keep this unit away from inverter fluorescent lights.
- Make sure the battery is installed correctly.
- Check the remaining battery level of the remote.
- Operate the remote control while aiming it at PARTY button (the remote sensor) on the unit.

The unit and AC adapter are getting hot.

- This is not a malfunction.

Trademarks, etc.

- PARTY STREAMING and the PARTY STREAMING logo are trademarks of Sony Corporation.
- Microsoft, Windows, Windows Vista, Windows 7™, Windows Media are trademarks or registered trademarks of Microsoft Corporation in the United States and/or other countries.
- This product is protected by certain intellectual property rights of Microsoft Corporation. Use or distribution of such technology outside of this product is prohibited without a license from Microsoft or an authorized Microsoft subsidiary.
-  The Wi-Fi Logo is a certification mark of the Wi-Fi Alliance.
- DLNA®, the DLNA Logo and DLNA CERTIFIED™ are trademarks, service marks, or certification marks of the Digital Living Network Alliance.
- Windows Media is either a registered trademark or trademark of Microsoft Corporation in the United States and/or other countries.
This product is protected by certain intellectual property rights of Microsoft Corporation. Use or distribution of such technology outside of this product is prohibited without a license from Microsoft or an authorized Microsoft subsidiary.
- MPEG Layer-3 audio coding technology and patents licensed from Fraunhofer IIS and Thomson.

WPA Supplicant

Copyright (c) 2003-2006, Jouni Malinen
<jkmaline@cc.hut.fi> and contributors
All Rights Reserved.

Redistribution and use in source and binary forms, with or without modification, are permitted provided that the following conditions are met:

- 1 Redistributions of source code must retain the above copyright notice, this list of conditions and the following disclaimer.
- 2 Redistributions in binary form must reproduce the above copyright notice, this list of conditions and the following disclaimer in the documentation and/or other materials provided with the distribution.
- 3 Neither the name(s) of the above-listed copyright holder(s) nor the names of its contributors may be used to endorse or promote products derived from this software without specific prior written permission.

THIS SOFTWARE IS PROVIDED BY THE COPYRIGHT HOLDERS AND CONTRIBUTORS "AS IS" AND ANY EXPRESS OR IMPLIED WARRANTIES, INCLUDING, BUT NOT LIMITED TO, THE IMPLIED WARRANTIES OF MERCHANTABILITY AND FITNESS FOR A PARTICULAR PURPOSE ARE DISCLAIMED. IN NO EVENT SHALL THE COPYRIGHT OWNER OR CONTRIBUTORS BE LIABLE FOR ANY DIRECT, INDIRECT, INCIDENTAL, SPECIAL, EXEMPLARY, OR CONSEQUENTIAL DAMAGES (INCLUDING, BUT NOT LIMITED TO, PROCUREMENT OF SUBSTITUTE GOODS OR SERVICES; LOSS OF USE, DATA, OR PROFITS; OR BUSINESS INTERRUPTION) HOWEVER CAUSED AND ON ANY THEORY OF LIABILITY, WHETHER IN CONTRACT, STRICT LIABILITY, OR TORT (INCLUDING NEGLIGENCE OR OTHERWISE) ARISING IN ANY WAY OUT OF THE USE OF THIS SOFTWARE, EVEN IF ADVISED OF THE POSSIBILITY OF SUCH DAMAGE.

- The system names and product names indicated in this manual are generally the trademarks or registered trademarks of the manufacturer.
- In this manual, Microsoft Windows XP Home Edition, Microsoft Windows XP Professional and Microsoft Windows XP Media Center Edition are referred to as Windows XP.
- In this manual, Microsoft Windows Vista Home Basic, Microsoft Windows Vista Home Premium, Microsoft Windows Vista Business and Microsoft Windows Vista Ultimate are referred to as Windows Vista.
- In this manual, Microsoft Windows 7 Home Basic, Microsoft Windows 7 Home Premium, Microsoft Windows 7 Professional and Microsoft Windows 7 Ultimate are referred to as Windows 7.
- ™ and ® marks are omitted in this manual.

<http://www.sony.net/>



* 4 2 6 5 3 0 5 1 1 * (1)